

APAVISA
PORCELANICO



neo
country
renewed emotions



masochist

renew your lifestyle

*A mixture of simplicity and romance,
halfway between
tradition and modernity
rural environment and urbanite*



*Mezcla de simplicidad y romance,
a medio camino entre
la tradición y la modernidad,
el ambiente rural y el urbanita*



*Style that connects
with memory and
emotions* *Un estilo que conecta
con los recuerdos y las
emociones*



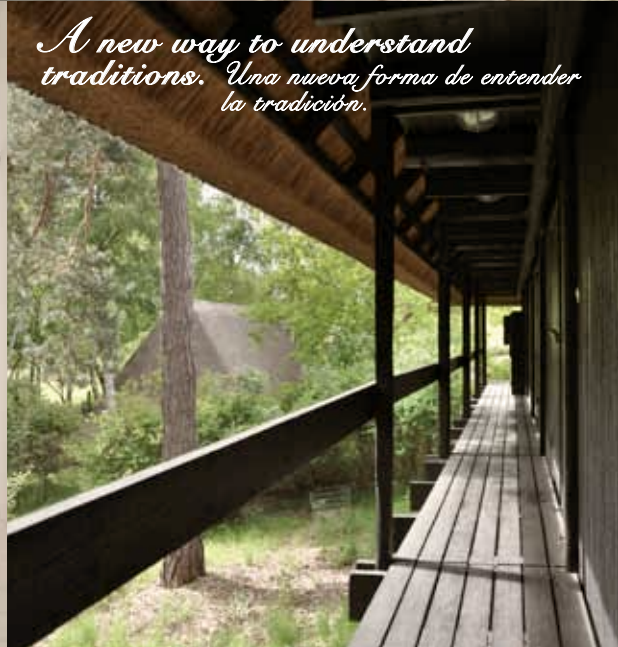

*A new way to understand
traditions. Una nueva forma de entender
la tradición.*

neocountry

GREY HEXAGONAL

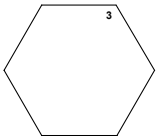

Neocountry serie hexagonal
(23,45° x 20,30° - 59,55 x 51,57 cm.)

Neocountry grey natural hexagonal

G-1458

FOR HEXAGONAL SIZES WE RECOMMEND 3 MM JOINT / PARA FORMATOS HEXAGONALES SE RECOMIENDA UNA JUNTA DE COLOCACIÓN DE 3 MM.

NON-GLAZED, RECTIFIED AND WITHOUT BEVEL EDGE FINISH PRODUCT / PRODUCTO NO ESMALTADO, RECTIFICADO Y NO BISELADO
TILES WITH RANDOM SHADE AND ASPECT VARIATION / PRODUCTO CON ALTA VARIACIÓN CROMÁTICA Y DESTONIFICACIÓN EN COMPOSICIONES





*La tradición es un buen soporte sobre el que
releer para crear e innovar.*

*Tradition is a great basis to research,
helping to re-create and innovate.*

GREY

neocountry

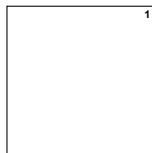

Neocountry serie 60x60
(23.45" x 23.45" - 59,55 x 59,55 cm.)

Neocountry grey natural 60x60 **G-1284**



Neocountry serie 30x60
(11.71" x 23.45" - 29,75 x 59,55 cm.)

Neocountry grey natural 30x60 **G-1218**

SPECIAL SIZES / FORMATOS ESPECIALES



Neocountry lista 7,5x60
(2,87" x 23.45" - 7,3 x 59,55 cm.)

Neocountry grey natural lista 7,5x60 **G-89**

Special pieces Piezas especiales



Neocountry grey natural mosaico 5x5
11.71" x 11.71" - 29,75 x 29,75 cm

G-1654



Neocountry policromático natural mosaico
11.71" x 11.71" - 29,75 x 29,75 cm

G-1708

NON-GLAZED, RECTIFIED AND WITHOUT BEVEL EDGE FINISH PRODUCT / PRODUCTO NO ESMALTADO, RECTIFICADO Y NO BISELADO
TILES WITH RANDOM SHADE AND ASPECT VARIATION / PRODUCTO CON ALTA VARIACIÓN CROMÁTICA Y DESTONIFICACIÓN EN COMPOSICIONES





product: neocountry grey natural 60x60

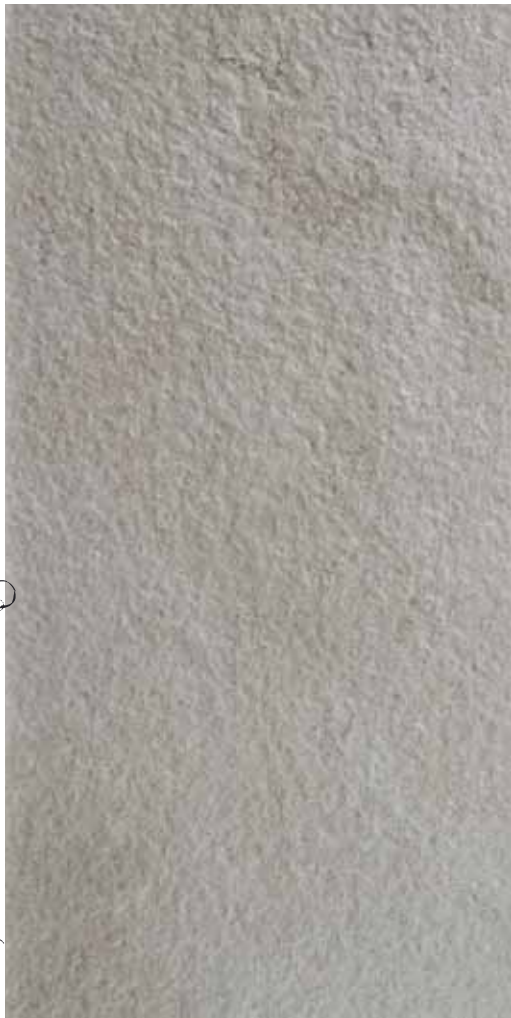

Neocountry serie 30x60
(11.71" x 23.45" - 29,75 x 59,55 cm.)

Neocountry grey bocciardato 30x60

G-1258

SPECIAL SIZES / FORMATOS ESPECIALES



Neocountry lista 7,5x60
(2.87" x 23.45" - 7,3 x 59,55 cm.)

Neocountry grey bocciardato lista 7,5x60

G-91

Special pieces / Piezas especiales



Neocountry grey bocciardato mosaico 7,5x15
11.71" x 11.71" - 29,75 x 29,75 cm

G-1616





TILES WITH RANDOM SHADE AND ASPECT VARIATION.
PRODUCTO CON ALTA VARIACIÓN CROMÁTICA Y DESTONIFICACIÓN EN COMPOSICIONES



Neocountry grey bocciardato 30x60



Outdoors

Antislip - Antideslizante

Clase 3*

***Bocciardato finish.** Acabado bocciardato





product: neocountry grey bocciardato 30x60

WHITE HEXAGONAL

neocountry

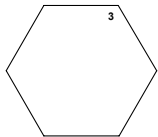

Neocountry serie hexagonal
(23.45" x 20.30" - 59,55 x 51,57 cm.)

Neocountry white natural hexagonal

G-1458

FOR HEXAGONAL SIZES WE RECOMMEND 3 MM JOINT / PARA FORMATOS HEXAGONALES SE RECOMIENDA UNA JUNTA DE COLOCACIÓN DE 3 MM.

NON-GLAZED, RECTIFIED AND WITHOUT BEVEL EDGE FINISH PRODUCT / PRODUCTO NO ESMALTADO, RECTIFICADO Y NO BISELADO
TILES WITH RANDOM SHADE AND ASPECT VARIATION / PRODUCTO CON ALTA VARIACIÓN CROMÁTICA Y DESTONIFICACIÓN EN COMPOSICIONES





product: neocountry white natural hexagonal 60x60

WHITE

neocountry

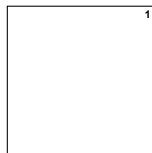

Neocountry serie 60x60
(23.45" x 23.45" - 59,55 x 59,55 cm.)

Neocountry white natural 60x60

G-1284



Neocountry serie 30x60
(11.71" x 23.45" - 29,75 x 59,55 cm.)

Neocountry white natural 30x60

G-1218

SPECIAL SIZES / FORMATOS ESPECIALES



Neocountry lista 7,5x60
(2.87" x 23.45" - 7,3 x 59,55 cm.)

Neocountry white natural lista 7,5x60

G-89

Special pieces Piezas especiales



Neocountry white natural mosaico 5x5
11.71" x 11.71" - 29,75 x 29,75 cm

G-1654



Neocountry policromático natural mosaico
11.71" x 11.71" - 29,75 x 29,75 cm

G-1708

NON-GLAZED, RECTIFIED AND WITHOUT BEVEL EDGE FINISH PRODUCT / PRODUCTO NO ESMALTADO, RECTIFICADO Y NO BISELADO
TILES WITH RANDOM SHADE AND ASPECT VARIATION / PRODUCTO CON ALTA VARIACIÓN CROMÁTICA Y DESTONIFICACIÓN EN COMPOSICIONES



Suggestive and peaceful atmospheres
Atmósferas sugerentes y apacibles



product: neocountry policromático natural mosaico - neocountry white natural 7,5x15



Neocountry serie 30x60
(11.71" x 23.45" - 29,75 x 59,55 cm.)

Neocountry white bocciardato 30x60 **G-1258**

SPECIAL SIZES / FORMATOS ESPECIALES



Neocountry lista 7,5x60
(2.87" x 23.45" - 7,3 x 59,55 cm.)

Neocountry white bocciardato lista 7,5x60 **G-91**



Special pieces Piezas especiales



Neocountry white bocciardato mosaico 7,5x15 **G-1616**
11.71" x 11.71" - 29,75 x 29,75 cm





product: neocountry white bocciardato 30x60

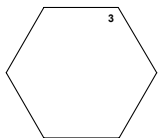

Neocountry serie hexagonal
(23,45" x 20,30" - 59,55 x 51,57 cm.)

Neocountry beige natural hexagonal 60x60

G-1458

FOR HEXAGONAL SIZES WE RECOMMEND 3 MM JOINT / PARA FORMATOS HEXAGONALES SE RECOMIENDA UNA JUNTA DE COLOCACIÓN DE 3 MM.

NON-GLAZED, RECTIFIED AND WITHOUT BEVEL EDGE FINISH PRODUCT / PRODUCTO NO ESMALTADO, RECTIFICADO Y NO BISELADO
TILES WITH RANDOM SHADE AND ASPECT VARIATION / PRODUCTO CON ALTA VARIACIÓN CROMÁTICA Y DESTONIFICACIÓN EN COMPOSICIONES



*Because you are different...
porque tú eres diferente*



product: neccountry beige natural hexagonal 60x60

BEIGE

neocountry

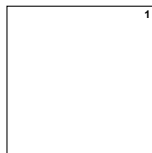

1

Neocountry serie 60x60
(23.45" x 23.45" - 59,55 x 59,55 cm.)

Neocountry beige natural 60x60 G-1284



2

Neocountry serie 30x60
(11.71" x 23.45" - 29,75 x 59,55 cm.)

Neocountry beige natural 30x60 G-1258

SPECIAL SIZES / FORMATOS ESPECIALES



Neocountry lista 7,5x60
(2.87" x 23.45" - 7,3 x 59,55 cm.)

Neocountry beige natural lista 7,5x60 G-91

Special pieces. Piezas especiales



Neocountry grey natural mosaico 5x5
11.71" x 11.71" - 29,75 x 29,75 cm

G-1654



Neocountry policromático natural mosaico
11.71" x 11.71" - 29,75 x 29,75 cm

G-1708

NON-GLAZED, RECTIFIED AND WITHOUT BEVEL EDGE FINISH PRODUCT / PRODUCTO NO ESMALTADO, RECTIFICADO Y NO BISELADO
TILES WITH RANDOM SHADE AND ASPECT VARIATION / PRODUCTO CON ALTA VARIACIÓN CROMÁTICA Y DESTONIFICACIÓN EN COMPOSICIONES



Suggestive and peaceful atmospheres
Atmósferas sugerentes y apacibles



product: neocountry beige natural 60x60



Neocountry serie 30x60
(11.71" x 23.45" - 29,75 x 59,55 cm.)

Neocountry beige bocciardato 30x60 **G-1258**

SPECIAL SIZES / FORMATOS ESPECIALES



Neocountry lista 7,5x60
(2.87" x 23.45" - 7,3 x 59,55 cm.)

Neocountry beige bocciardato lista 7,5x60 **G-91**



Special pieces / Piezas especiales



Neocountry beige bocciardato mosaico 7,5x15 **G-1616**
11.71" x 11.71" - 29,75 x 29,75 cm





product: neocountry beige bocciardato 30x60



fusion
of
textures

mezcla de
texturas

monocromático

grey



TILES WITH RANDOM SHADE AND
ASPECT VARIATION / PRODUCTO
CON ALTA VARIACIÓN CROMÁTICA Y
DESTONIFICACIÓN EN COMPOSICIONES



neocountry grey natural 60x60

beige



TILES WITH RANDOM SHADE AND
ASPECT VARIATION / PRODUCTO
CON ALTA VARIACIÓN CROMÁTICA Y
DESTONIFICACIÓN EN COMPOSICIONES



neocountry beige natural 60x60

white



TILES WITH RANDOM SHADE AND
ASPECT VARIATION / PRODUCTO
CON ALTA VARIACIÓN CROMÁTICA Y
DESTONIFICACIÓN EN COMPOSICIONES



neocountry white natural 60x60

SPECIAL PIECES / PIEZAS ESPECIALES

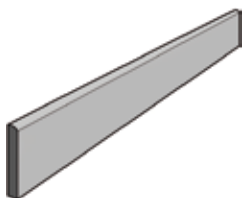

▲ **SKIRTING. RODAPIÉ**
7,5 x 60 cm (7,3 x 59,55 cm)



▲ **COVEBASE 60°***
15 x 59,55 x 7,8 cm

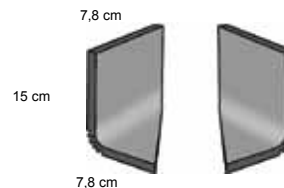

▲ **COVEBASE ÁNGULO INTERIOR***

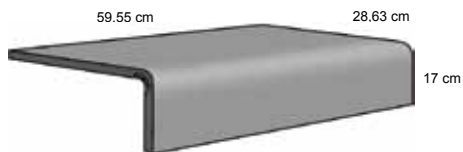

▲ **STEP L 60°***
28,63 x 59,55 x 17 cm

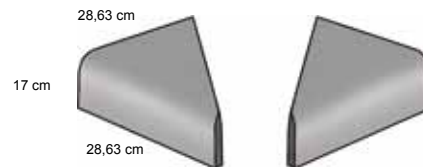

▲ **STEP - L ÁNGULO EXTERIOR***
28,63 x 28,63 x 17 cm

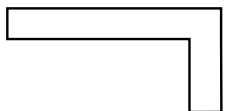

ZANQUIN PELDAÑO LISTELO

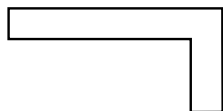

ZANQUIN PELDAÑO RODAPIÉ

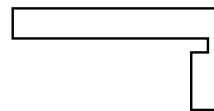

ZANQUIN GRADONE LISTELO

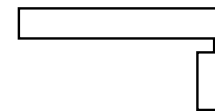

ZANQUIN GRADONE RODAPIÉ

* Article produced by special order and for minimum quantities of 100 pieces. Delivery time 60 days from the order confirmation. No minimum quantity required on the angle if ordered together with the minimum quantities of the covebase- 60 or Step-L 60. Check packing list by type of piece and order.

* Artículo sobre pedido. Cantidad mínima 100 piezas. Plazo de entrega 60 días. Ángulos sin mínimo. Sólo se realizarán cuando se curse pedido mínimo de la pieza covebase 60 o step - L 60.

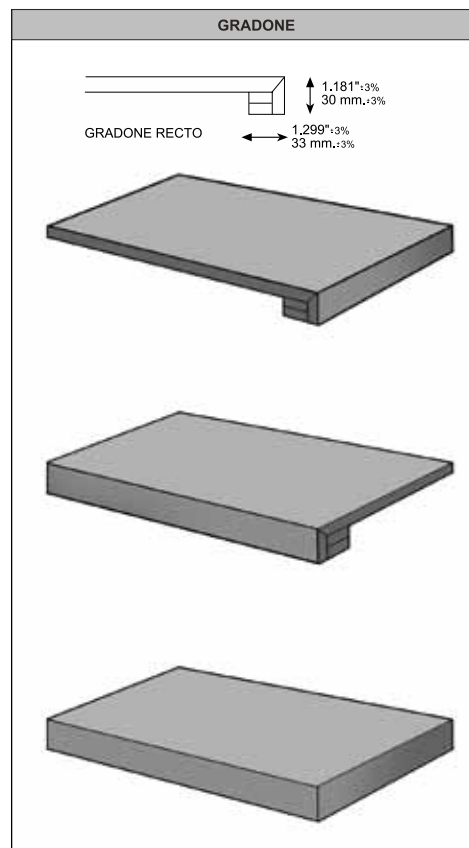
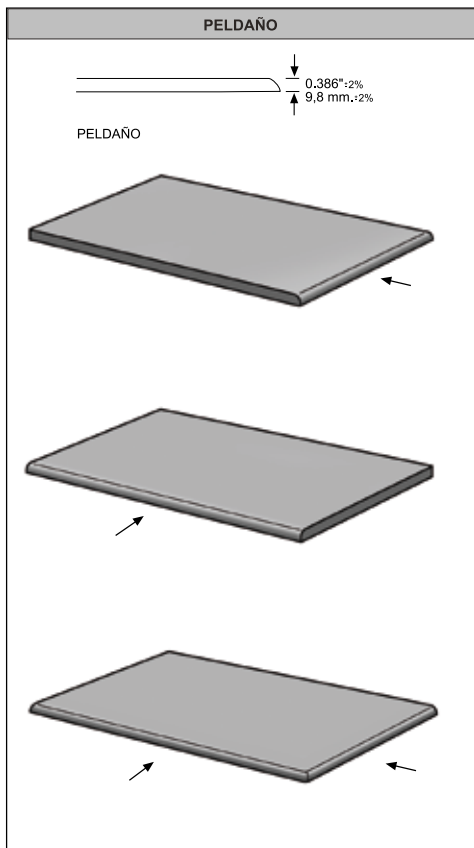

All these products are also available with grooves / All steps are available in all colours and finishes. / Angle steps are available in all step types and sizes.

Todos estos productos también se pueden realizar con ranuras por indicación expresa. / Todos los peldaños se fabrican en todos los colores y acabados de la serie. / Los peldaños ángulo están disponibles en todos los tipos de peldaño y formatos citados.



Recycled material used in production up to 40%

Material reciclado usado en la producción hasta un 40%



The production process is a closed cycle without emission of pollutants to the environment.

Todo el proceso productivo es un ciclo cerrado, sin emisión de contaminantes al medio ambiente.



22% of primary energy savings in the cogeneration process.

22% de ahorro de energía primaria en el proceso de cogeneración.



CERTIFICATIONS AND RECOGNITIONS - CERTIFICADOS Y RECONOCIMIENTOS

CERTIFICATE ISO 14001: 2004

Environmental manage system
Sistema de gestión ambiental



MEMBER OF U.S. GREEN BUILDING COUNCIL / MIEMBRO DEL CONSEJO CONSTRUCCIÓN VERDE DE ESTADOS UNIDOS

The USGBC (U.S. Green Building Council), with more than 15,000 member organisations from the construction industry, works to promote buildings that are environmentally friendly, productive and healthy locations where to live and work.

El USGBC (U.S. Green Building Council), con más de 15.000 organizaciones miembros de todos los sectores de la construcción, trabaja para promover los edificios que son medioambientalmente responsables, rentables y lugares sanos donde vivir y trabajar.



APAVISA PORCELÁNICO has the **INTEGRATED ENVIRONMENTAL AUTHORIZATION** (issued by The Center for Climate Change, at the Environment, Water and Urban Development Council of Comunidad Valenciana, according to a resolution dated 28th of November, 2007. 2008/1866).

APAVISA PORCELÁNICO dispone de la **AUTORIZACIÓN AMBIENTAL INTEGRADA** (otorgada por la Dirección General para el Cambio Climático, de la Conselleria de Medio Ambiente, Agua, Urbanismo y Vivienda de la Comunidad Valenciana, según resolución del 28 de Noviembre de 2007. 2008/1866).

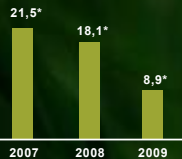

REDUCTION OF GREENHOUSE GASES. REDUCCIÓN DE LOS GASES DE EFECTO INVERNADERO.

*Total emissions CO2 (thousands of Tn) . Emisiones totales CO2 (miles de Tn)

Verified by. Verificado por:



NEOCOUNTRY collection



PRICE GROUPS / GRUPOS DE PRECIO

NEOCOUNTRY collection		GREY	BEIGE	WHITE
NEOCOUNTRY HEXAGONAL / SERIE NEOCOUNTRY HEXAGONAL		NATURAL	NATURAL	NATURAL
BASE HEXAGONAL L306	23.45" x 23.45" - 59,55 x 59,55 cm.	1458	1458	1458

NEOCOUNTRY collection		GREY	BEIGE	WHITE
NEOCOUNTRY SERIE 60X60 / SERIE NEOCOUNTRY 60X60		NATURAL	NATURAL	NATURAL
BASE 60X60	23.45" x 23.45" - 59,55 x 59,55 cm.	1284	1284	1284
PELDAÑO-60	23.45" x 23.45" - 59,55 x 59,55 cm.	265	265	265
PELDAÑO ANGULO 60X60	23.45" x 23.45" - 59,55 x 59,55 cm.	281	281	281
PELDAÑO GRAD-60	23.45" x 23.45" - 59,55 x 59,55 cm.	559	559	559
PELDAÑO GRAD ANG 60X60	23.45" x 23.45" - 59,55 x 59,55 cm.	623	623	623















NEOCOUNTRY collection		GREY		BEIGE		WHITE	
NEOCOUNTRY SERIE 30X60 / SERIE NEOCOUNTRY 30X60		NATURAL	BOCCIARDATO	NATURAL	BOCCIARDATO	NATURAL	BOCCIARDATO
BASE 30X60	11.71" x 23.45" - 29,75 x 59,55 cm.	1218	1258	1218	1258	1218	1234
PELDAÑO-30 30X60	11.71" x 23.45" - 29,75 x 59,55 cm.	171	171	171	171	171	171
PELDAÑO-60 30X60	11.71" x 23.45" - 29,75 x 59,55 cm.	171	171	171	171	171	171
PELDAÑO ANGULO 30X60	11.71" x 23.45" - 29,75 x 59,55 cm.	187	187	187	187	187	187
PELDAÑO GRAD-30 30X60	11.71" x 23.45" - 29,75 x 59,55 cm.	499	499	499	499	499	499
PELDAÑO GRAD-60 30X60	11.71" x 23.45" - 29,75 x 59,55 cm.	499	499	499	499	499	499
PELDAÑO GRAD ANG 30X60	11.71" x 23.45" - 29,75 x 59,55 cm.	559	559	559	559	559	559

NEOCOUNTRY collection		GREY		BEIGE		WHITE	
PIEZAS ESPECIALES / SPECIAL PIECES		NATURAL	BOCCIARDATO	NATURAL	BOCCIARDATO	NATURAL	BOCCIARDATO
MOSAICO 5X5	11.71" x 11.71" - 29,75 x 29,75 cm.	1654	85	1654	85	1654	85
MOSAICO 7,5X15	11.71" x 11.71" - 29,75 x 29,75 cm.	-	1616	-	1616	-	1616
MOSAICO POLICROMÁTICO	11.71" x 11.71" - 29,75 x 29,75 cm.	-	1708	-	1708	-	1708
LISTELO 7,5X60	2.87" x 23.45" - 7,3 x 59,55 cm.	89	91	89	91	89	91
RODAPIÉ 7,5X60	2.87" x 23.45" - 7,3 x 59,55 cm.	93	95	93	95	93	95
TACO 7,5X7,5	2.87" x 2.87" - 7,3 x 7,3 cm.	29	35	29	35	29	35
ZANQUIN PELDAÑO LISTELO	2.87" x 11.71" x23.45" - 7,3 x 29,75 x 59,55 cm	179	187	179	187	179	187
ZANQUIN PELDAÑO RODAPIÉ	2.87" x 11.71" x23.45" - 7,3 x 29,75 x 59,55 cm	187	195	187	195	187	195
ZANQUIN GRADONE LISTELO	2.87" x 11.71" x23.45" - 7,3 x 29,75 x 59,55 cm	179	187	179	187	179	187
ZANQUIN GRADONE RODAPIÉ	2.87" x 11.71" x23.45" - 7,3 x 29,75 x 59,55 cm	187	195	187	195	187	195
STEP - L 60*	11" x 23.45" x 6.7" - 28 x 59,55 x 17 cm	559	-	559	-	559	-
STEP - L 60 ANGULO EXTERIOR*	11" x 11" x 6.7" - 28 x 28 x 17 cm	623	-	623	-	623	-
COVEBASE 60*	5.9" x 23.45" x 3.07" - 15 x 59,55 x 7,8 cm	499	-	499	-	499	-
COVEBASE ÁNGULO INTERIOR*	5.9" x 5.9" x 3.07" - 15 x 15 x 7,8 cm	559	-	559	-	559	-

* Article produced by special order and for minimum quantities of 100 pieces. Delivery time 60 days from the order confirmation. No minimum quantity required on the angle if ordered together with the minimum quantities of the covebase- 60 or step-L 60.
 * Artículo sobre pedido. Cantidad mínima 100 piezas. Plazo de entrega 60 días. Ángulos sin mínimo. Sólo se realizarán cuando se curse pedido mínimo de la pieza covebase 60 o step - L 60.

PLEASE, CONSULT GENERAL PACKING LIST IN GENERAL CATALOGUES OR ON OUR WEB SITE www.apavisa.com / POR FAVOR, CONSULTEN LA LISTA GENERAL DE EMBALAJES EN NUESTROS CATÁLOGOS GENERALES O NUESTRA PÁGINA WEB www.apavisa.com

NEOCOUNTRY collection. TECHNICAL CHARACTERISTICS / Colección NEOCOUNTRY. CARACTERÍSTICAS TÉCNICAS

TECHNICAL CHARACTERISTICS CARACTERÍSTICAS TÉCNICAS	STANDARD TEST METHOD MÉTODO DE LA NORMA	STANDARD PRESCRIBED VALUES VALOR PRESCRITO POR LA NORMA	APAVISA VALUE VALOR APAVISA
MEASUREMENTS SURFACE APPEARANCE / DIMENSIONES Y ASPECTO SUPERFICIAL			
 LENGTH AND WIDTH / LONGITUD Y ANCHURA	UNE - EN ISO 10545 - 2	+/- 0.6 % max	+/- 0.2 %
 THICKNESS / ESPESOR	UNE - EN ISO 10545 - 2	+/- 5.0 % max	+/- 2.0 %
 ORTHOGONALITY / ORTOGONALIDAD	UNE - EN ISO 10545 - 2	+/- 0.6 % max	+/- 0.2 %
 SURFACE FLATNESS / PLANITUD DE SUPERFICIE	UNE - EN ISO 10545 - 2	+/- 0.5 % max	+/- 0.2 %
PHYSICAL PROPERTIES / PROPIEDADES FÍSICAS			
 WATER ABSORPTION / ABSORCIÓN DE AGUA	UNE - EN ISO 10545 - 3	≤ 0.5 %	+/- 0.1 %
 BENDING RESISTANCE / RESISTENCIA A LA FLEXIÓN	UNE - EN ISO 10545 - 4	≥ 27 N/mm ²	61 N/mm ²
 SURFACE SCRATCH RESISTANCE / DUREZA AL RAYADO SUPERFICIAL	EN 101	≥ MOHS 6	MOHS 7
 RESISTANCE TO ABRASION / RESISTENCIA A LA ABRASIÓN	UNE - EN ISO 10545 - 6	≤ 205 mm ³	129 mm ³
 THERMAL EXPANSION COEFFICIENT / COEF. DE DILATACIÓN TÉRMICA	UNE - EN ISO 10545 - 8	≤ 9 MK ⁻¹	6,3 MK ⁻¹
 TEMPERATURE SHOCK RESISTANCE / RESISTENCIA AL CHOQUE TERMICO	UNE - EN ISO 10545 - 9	NO SURFACE DEFECTS SHOULD BE VISIBLE <small>NO DEBE PRESENTAR DEFECTOS VISIBLES</small>	DURABLE / Resistente
 RESISTANCE TO COLD / RESISTENCIA A LA HELADA	UNE - EN ISO 10545 - 12	NO SURFACE DEFECTS OR CRACKS SHOULD BE VISIBLE <small>NO DEBE PRESENTAR DEFECTOS O ROTURAS VISIBLES</small>	ANTI-ICE / Antihielo
 ANTI - SLIP / ANTIDESLIZAMIENTO	DIN 51130 / UNE - ENV 12633		CLASE 1* / CLASE 3**
 COLOUR RESISTANCE TO LIGHT / RESISTENCIA DEL COLOR A LA LUZ	DIN 51094	THERE SHOULD BE NO COLOUR VARIATIONS <small>NO DEBE PRESENTAR VARIACIONES DE COLOR</small>	NO ALTERATIONS
CHEMICAL PROPERTIES / PROPIEDADES QUÍMICAS			
 CHEMICAL RESISTANCE / RESISTENCIA QUÍMICA	UNE - EN ISO 10545 - 13	THERE SHOULD BE NO VISIBLE CHANGES <small>NO DEBE PRESENTAR ALTERACIONES VISIBLES A LOS ATAQUES QUÍMICOS</small>	RESISTANT / Resistente
 RESISTANCE TO STAINING / RESISTENCIA A LAS MANCHAS	UNE - EN ISO 10545 - 14	THERE SHOULD BE NO VISIBLE CHANGES <small>NO DEBE PRESENTAR ALTERACIONES VISIBLES A LOS ATAQUES QUÍMICOS</small>	NO VISIBLE DEFECTS <small>SIN DEFECTOS VISIBLES</small>

* Test done in neocountry grey natural 60x60. Average test result value on September 2010. Consult specific product test result value before supplying. Possibility of other tests by request.
Every natural finish product can be manufactured on a higher non slip grade by request.

* Prueba realizada sobre el producto neocountry grey natural 60x60. Valor de media a fecha Septiembre de 2010. Consultar valor de un producto específico antes del suministro. Posibilidad de realizar ensayos diferentes. Los productos con acabado mate pueden ser fabricados con un grado de antideslizamiento mayor bajo solicitud expresa.

** Test done in neocountry grey bocciardato 30x60. Average test result value on September 2010. Consult specific product test result value before supplying. Possibility of other tests by request.
Every natural finish product can be manufactured on a higher non slip grade by request.

* Prueba realizada sobre el producto neocountry grey bocciardato 30x60. Valor de media a fecha Septiembre de 2010. Consultar valor de un producto específico antes del suministro.
Posibilidad de realizar ensayos diferentes. Los productos con acabado mate pueden ser fabricados con un grado de antideslizamiento mayor bajo solicitud expresa.

APAVISA PORCELÁNICO S.L. does not take any responsibility of printing mistakes in any data of this catalogue. Check and confirm the data with APAVISA PORCELÁNICO S.L., before any order. All technical characteristics and specifications are based on the available information at the printing moment, they can suffer alterations without warning according to changes in markets, in technological innovations or in any other factor. APAVISA PORCELÁNICO S.L. has the right to modify them without any responsibility or any commitment.

APAVISA PORCELÁNICO S.L. no asume ninguna responsabilidad por posibles errores de impresión en cualquier dato reflejado en el presente catálogo. Por tal motivo, para la realización de cualquier pedido se solicita que sean confirmados a APAVISA PORCELÁNICO S.L. o a su distribuidor. Todas las características y especificaciones técnicas están basadas en la información disponible en el momento de la impresión del presente catálogo y podrán cambiar o variar sin previo aviso de acuerdo a las circunstancias del mercado y/o a las innovaciones tecnológicas y/o a cualquier otro factor. APAVISA PORCELÁNICO S.L. se reserva el derecho a modificarlos en cualquier otro momento sin incurrir en ninguna obligación ni responsabilidad.

Distributed by - Distribuido por - Distribuito da - Vertrieben durch - Distribue par

APAVISA
PORCELÁNICO

Ctra. Castellón - San Juan de Moró, hm. 7,5 - 12130 SAN JUAN DE MORÓ (Castellón) Spain
Tel. +34 964 701 120 - Export Fax +34 964 701 067 - Fax Nacional 964 701 195 - info@apavisa.com

www.apavisa.com



PLEASE RECYCLE WHEN OBSOLETE
POR FAVOR RECLICAR CUANDO QUEDE OBSOLETO
WENN NICHT MEHR AKTUELL, RECYCELN
PER FAVORE RICICLARLO QUANDO VECCHIO
S'IL VOUS PLAÎT, MERCI DE RECYCLER

NEO1/0910