

SPECIFICATION SHEET

COLLECTION: NOTION

PRODUCT CODE: IND-T148/2-NOT-BRG



DESCRIPTION:

Tablet Notion vertical concealed 2 outlet 2 handle
thermostatic shower valve with all-flow function
wall mounted
thermostatic cartridge V-001C-PLA
diverter cartridge TAB-001G-DIV
2 x 3/4" female inlets
2 x 3/4" female outlets
includes 3/4" - 1/2" adaptors
supplied with mortar/tile guard
min-max wall mount 75-100mm
optimum installation depth 87mm
minimum operating pressure
0.2 bar LP (shower) 1.0 bar MP (bath)

FINISH:

Brushed Gold

MINIMUM OPERATING PRESSURE:

0.2 bar LP (shower) 1.0 bar MP (bath)

FLOW RATE AT 3.0 BAR FLOW PRESSURE:

32 l/min

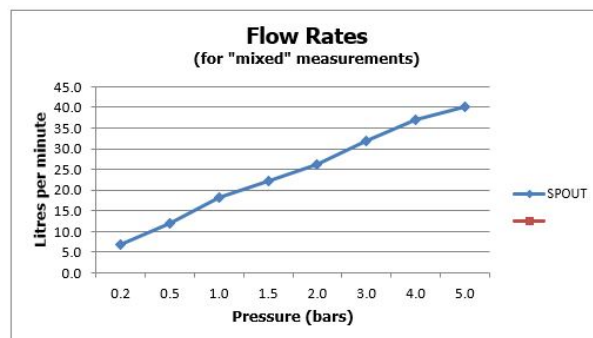

tel: 01934 744466
email: sales@vado.com
www.vado.com

where inspiration flows
taps | showering | accessories



TECHNICAL DRAWING

COLLECTION: NOTION

PRODUCT CODE: IND-T148/2-NOT-BRG

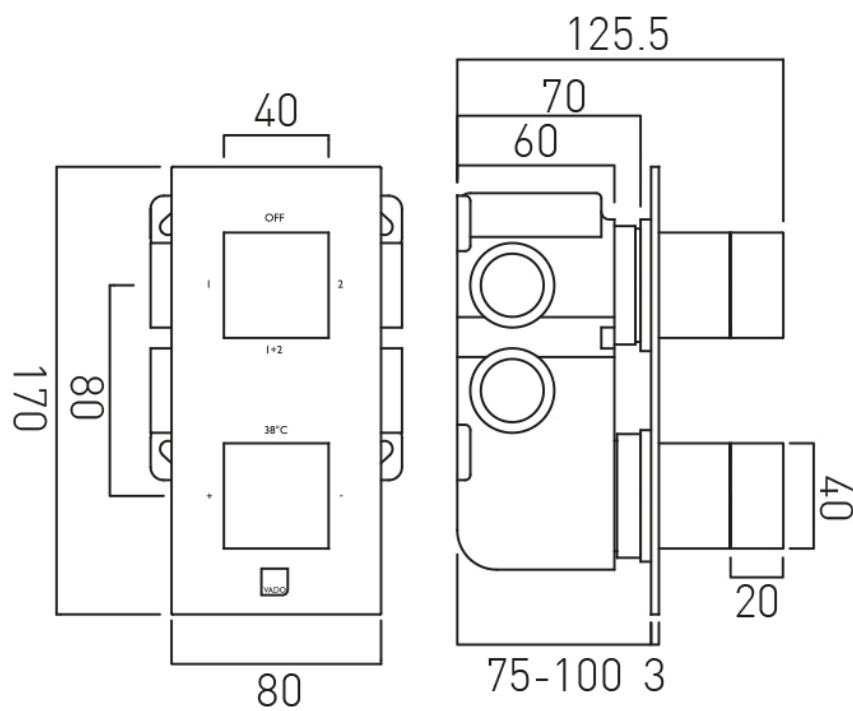

tel: 01934 744466
email: sales@vado.com
www.vado.com

where inspiration flows
taps | showering | accessories



SPECIFICATION SHEET

COLLECTION: INDIVIDUAL

PRODUCT CODE: IND-SQ/30-BRG

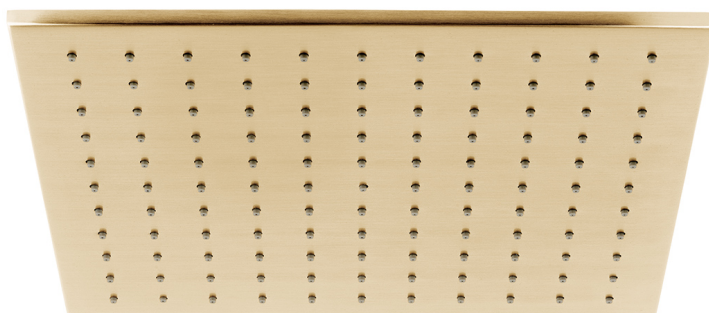

DESCRIPTION:

single function easy clean slim line square shower head
300mm (12")

minimum operating pressure 0.2 bar LP

FINISH:

Brushed Gold

MINIMUM OPERATING PRESSURE:

0.2 bar LP

FLOW RATE AT 3.0 BAR FLOW PRESSURE:

24 l/min

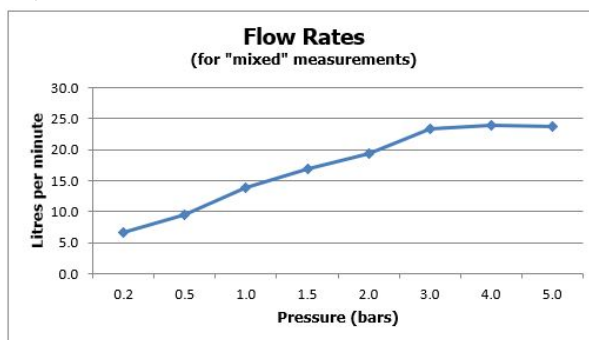

tel: 01934 744466
email: sales@vado.com
www.vado.com

where inspiration flows
taps | showering | accessories



TECHNICAL DRAWING

COLLECTION: INDIVIDUAL

PRODUCT CODE: IND-SQ/30-BRG

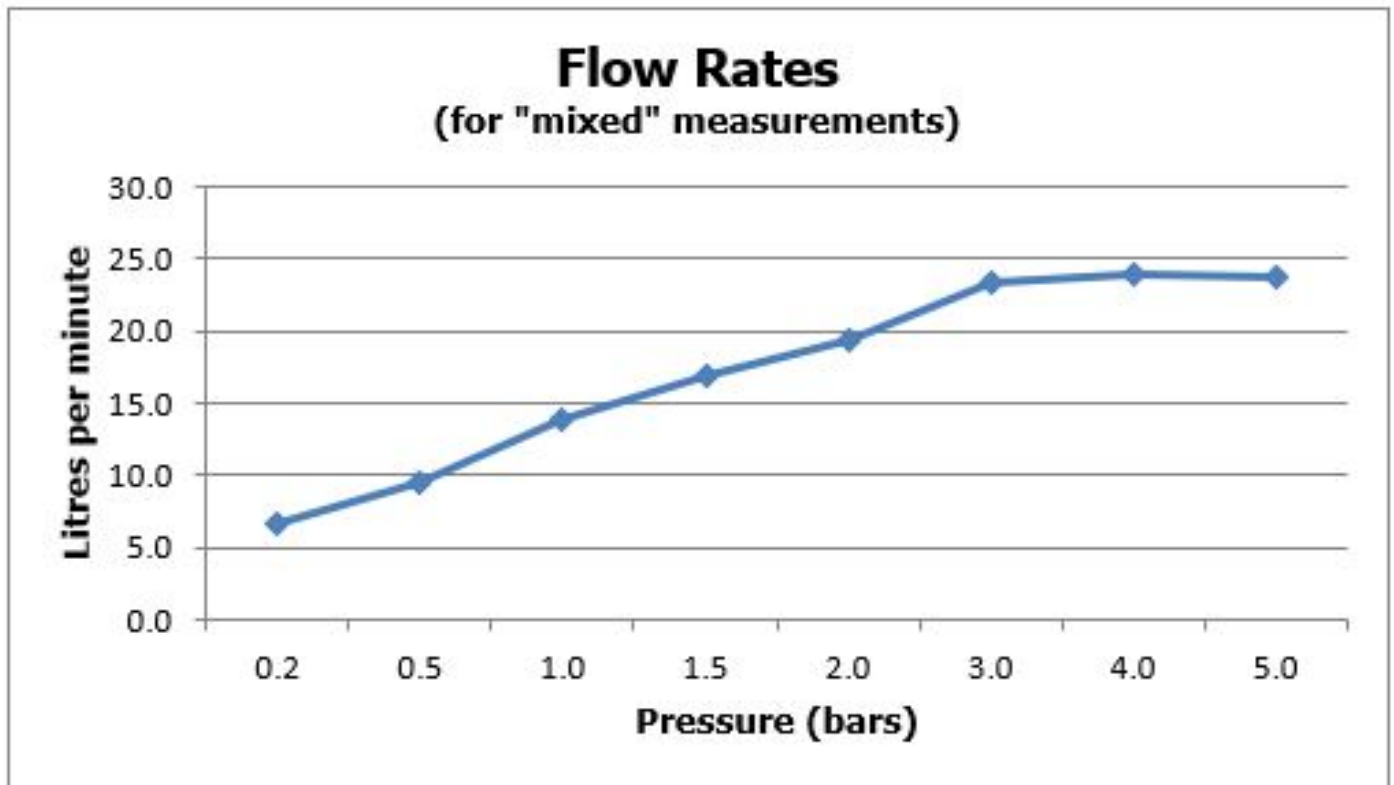

tel: 01934 744466
email: sales@vado.com
www.vado.com

where inspiration flows
taps | showering | accessories



SPECIFICATION SHEET

COLLECTION: INDIVIDUAL

PRODUCT CODE: IND-EFSA/SQ-BRG



DESCRIPTION:

shower arm square easy fit wall mounted

FINISH:

Brushed Gold



tel: 01934 744466
email: sales@vado.com
www.vado.com

where inspiration flows
taps | showering | accessories



TECHNICAL DRAWING

COLLECTION: INDIVIDUAL

PRODUCT CODE: IND-EFSA/SQ-BRG

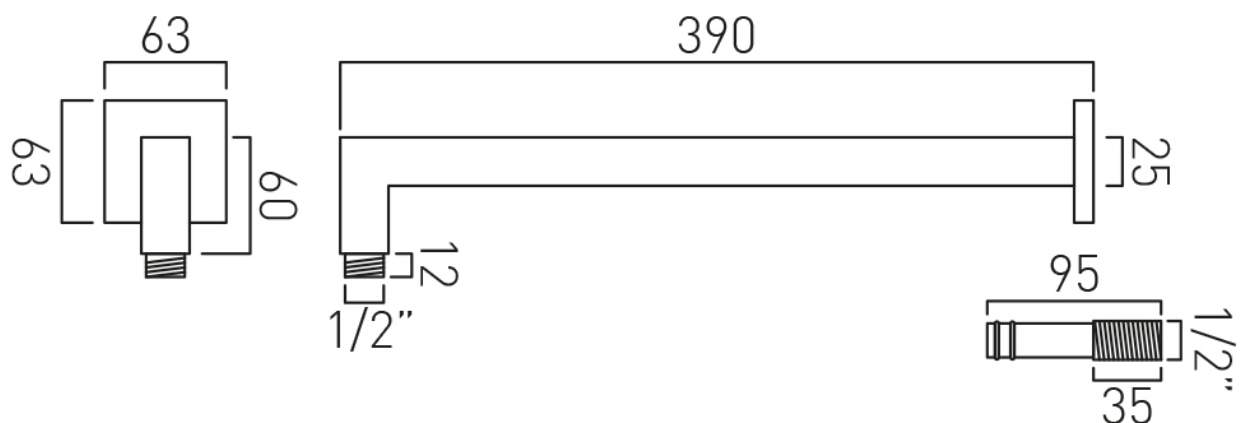

tel: 01934 744466
email: sales@vado.com
www.vado.com

where inspiration flows
taps | showering | accessories



SPECIFICATION SHEET

COLLECTION: INDIVIDUAL

PRODUCT CODE: IND-SFMKWO/SQ-BRG

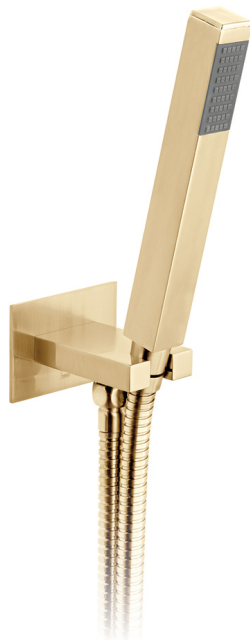

DESCRIPTION:

single function mini shower kit
wall mounted
with hose and bracket with integral outlet
1/2" inlet
minimum operating pressure 1.0 bar MP

FINISH:

Brushed Gold

MINIMUM OPERATING PRESSURE:

1.0 bar MP

FLOW RATE AT 3.0 BAR FLOW PRESSURE:

14 l/m

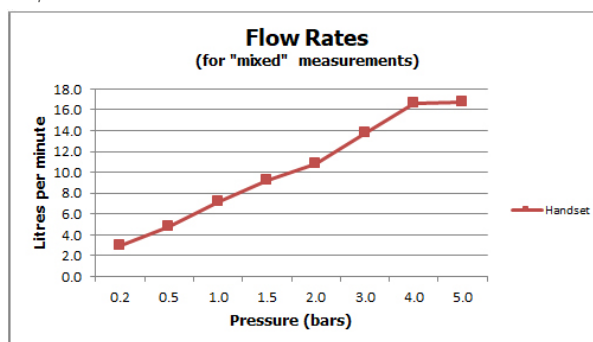

tel: 01934 744466
email: sales@vado.com
www.vado.com

where inspiration flows
taps | showering | accessories



TECHNICAL DRAWING

COLLECTION: INDIVIDUAL

PRODUCT CODE: IND-SFMKWO/SQ-BRG

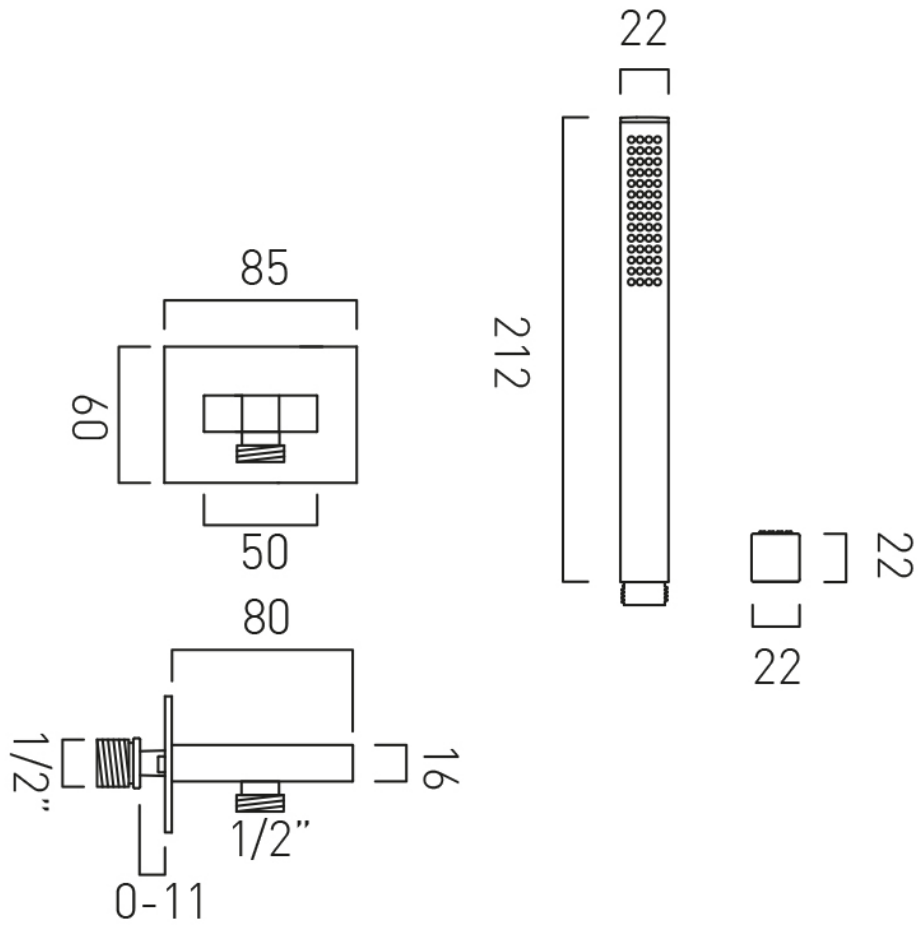

tel: 01934 744466
email: sales@vado.com
www.vado.com

where inspiration flows
taps | showering | accessories

