

YOUNG 2.0 G+F



KABINA NAROŻNA, SKRZYDŁO OTWIERANE + ŚCIANKA BOCZNA

Rozmiar			Kod	Szyba			Kolor profilai			
Wymiar całkowity	Szerokość wejścia	Skrzydło po otwarciu		1	2	4	D	B	K	H
A	*	B		Przeźroczysta	Aqua	Satyna	Biały	Srebrny	Chrom	Czarny
DRZWI										
57 ↔ 59	48	49	Y2G57-							
59 ↔ 61	50	51	Y2G59-							
61 ↔ 63	52	53	Y2G61-							
65 ↔ 67	56	57	Y2G65-							
67 ↔ 69	58	59	Y2G67-							
69 ↔ 71	60	61	Y2G69-							
72 ↔ 74	63	64	Y2G72-							
74 ↔ 76	65	66	Y2G74-							
76 ↔ 78	67	68	Y2G76-							
77 ↔ 79	68	69	Y2G77-							
79 ↔ 81	70	71	Y2G79-							
81 ↔ 83	72	73	Y2G81-							
85 ↔ 87	76	77	Y2G85-							
87 ↔ 89	78	79	Y2G87-							
89 ↔ 91	80	81	Y2G89-							
91 ↔ 93	82	83	Y2G91-							
95 ↔ 97	86	87	Y2G95-							
97 ↔ 99	88	89	Y2G97-							
99 ↔ 101	90	91	Y2G99-							
101 ↔ 103	92	93	Y2G101-							
H 140 ↓ 200 L 57 ↔ 103		Rozmiar specjalny	Y2GSP							

Rozmiar			Kod	Szyba			Kolor profilai			
F				1	2	4	D	B	K	H
				Przeźroczysta	Aqua	Satyna	Biały	Srebrny	Chrom	Czarny
ŚCIANKA BOCZNA										
57 ↔ 59	◇	◇	Y2FG57-							
59 ↔ 61	◇	◇	Y2FG59-							
61 ↔ 63	◇	◇	Y2FG61-							
65 ↔ 67	◇	◇	Y2FG65-							
67 ↔ 69	◇	◇	Y2FG67-							
69 ↔ 71	◇	◇	Y2FG69-							
73 ↔ 75	◇	◇	Y2FG73-							
75 ↔ 77	◇	◇	Y2FG75-							
76 ↔ 78	◇	◇	Y2FG76-							
77 ↔ 79	◇	◇	Y2FG77-							
79 ↔ 81	◇	◇	Y2FG79-							
81 ↔ 83	◇	◇	Y2FG81-							
85 ↔ 87	◇	◇	Y2FG85-							
87 ↔ 89	◇	◇	Y2FG87-							
89 ↔ 91	◇	◇	Y2FG89-							
91 ↔ 93	◇	◇	Y2FG91-							
95 ↔ 97	◇	◇	Y2FG95-							
97 ↔ 99	◇	◇	Y2FG97-							
99 ↔ 101	◇	◇	Y2FG99-							
101 ↔ 103	◇	◇	Y2FG101-							
117 ↔ 119	◇	◇	Y2FG117-							
119 ↔ 121	◇	◇	Y2FG119-							
H 100 ↓ 220 L 20 ↔ 120		Rozmiar specjalny	Y2FGSP							

Jeśli ścianka ma być wykonana w wymiarze specjalnym musi być tej samej wysokości, co drzwi.

Drażek stabilizacyjny 100 cm wliczony do ceny ścianki bocznej.

W przypadku zamówienia wykończenia złotego należy doliczyć +10% do koloru chrom (K)

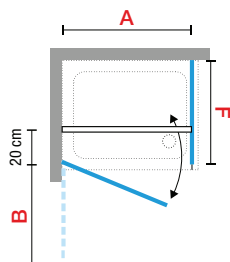
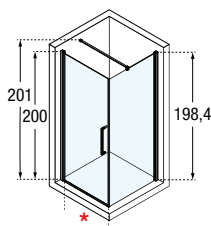

Konstrukcja kodu

Kod



Szyba



Profil



Ostateczny kod produktu

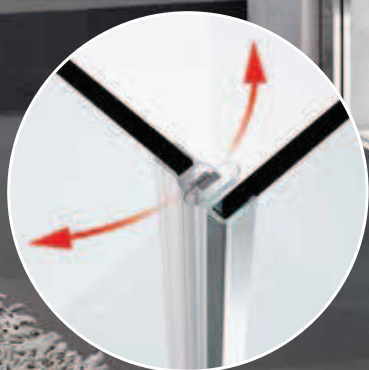

Otwieranie na zewnątrz i do środka

OPCJE



Drażek stabilizacyjny 45 stopni

Rozmiar	Kod	Chrom K	Czarny H	Złoty O
25 cm	R80LOU250-			
35 cm	R80LOU350-			
45 cm	R80LOU450-			



Drażek stabilizacyjny 90 stopni, 150 cm do skracania

Kolor	Kod	
Biały	R80Y220-D	
Srebrny	R80Y220-B	
Chrom	R80Y220-K	
Złoty	R80Y220-O	
Czarny	R80Y220-H	



Drażek stabilizacyjny z możliwością ustawienia kąta montażu

- 1 drążek ruchomy
- 1 mocowanie ścienne
- 1 nakładka dystansowa

Kolor	Kod	
Biały	R80KUOR100-D	
Srebrny	R80KUOR100-B	
Chrom	R80KUOR100-K	
Czarny	R80KUOR100-H	



Zestaw montażowy T

- 2 drążki stabilizacyjne 150 cm
- 1 mocowanie ścienne
- 2 nakładki dystansowe
- 1 łącznik

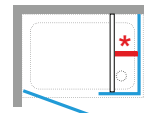

Kolor	Kod	
Biały	R80Y215T-D	
Srebrny	R80Y215T-B	
Chrom	R80Y215T-K	
Złoty	R80Y215T-O	
Czarny	R80Y215T-H	

DANE TECHNICZNE

SZYBA 6 mm (Standardy europejskie UNE EN 14428)

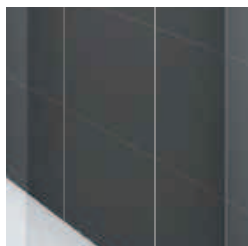

Przeźroczysta
KOD 1



Aqua
KOD 2



Satyna
KOD 4

UCHWYT



Uchwyt mosiężny chromowany
dł. 384 mm

KOLORY PROFILI



Biały
KOD D



Srebrny
KOD B



Chrom
KOD K



Czarny
KOD H



Złoty
KOD O
Na zamówienie

WYMIARY PROFILI MONTAŻOWYCH

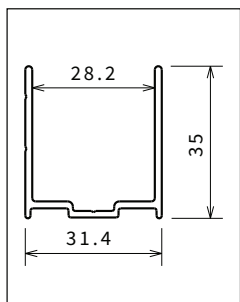

Profil przysięenny

Wysokość	Kolor	Kod
1984	Biały	P01BNMOBST-A
	Srebrny	P01BNMOBST-B
	Chrom	P01BNMOBST-K
	Czarny	P01BNMOBST-H
2000	Biały	P01BNMOAST-A
	Srebrny	P01BNMOAST-B
	Chrom	P01BNMOAST-K
	Czarny	P01BNMOAST-H

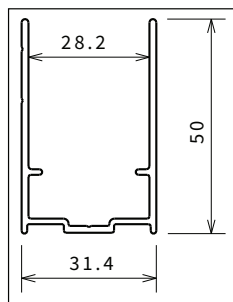

Profil poszerzający

Wysokość	Kolor	Kod
1984	Biały	P05Y2ST-A
	Srebrny	P05Y2ST-B
	Chrom	P05Y2ST-K
	Czarny	P05Y2ST-H
2000	Biały	P05Y2ST2-A
	Srebrny	P05Y2ST2-B
	Chrom	P05Y2ST2-K
	Czarny	P05Y2ST2-H

Po więcej informacji o kodach i cenach zapraszamy na stronę 426

JAK PRAWIDŁOWO DOKONAĆ POMIARÓW

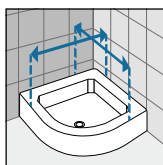
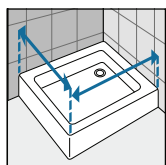

W celu poprawnego doboru produktu należy wziąć dystans od ściany do zewnętrznej krawędzi brodzika wg rysunków technicznych. Wymiary muszą być zmierzone po wypytkowaniu ścian.

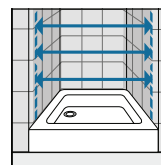

Wersja do wnęki po uprzednim zmierzeniu dystansów u góry, w środku oraz na dole niszy i wzięciu najmniejszego spośród tych wymiarów wg rysunków technicznych. Wymiary muszą być zmierzone po wypytkowaniu ścian.

RYSUNKI TECHNICZNE

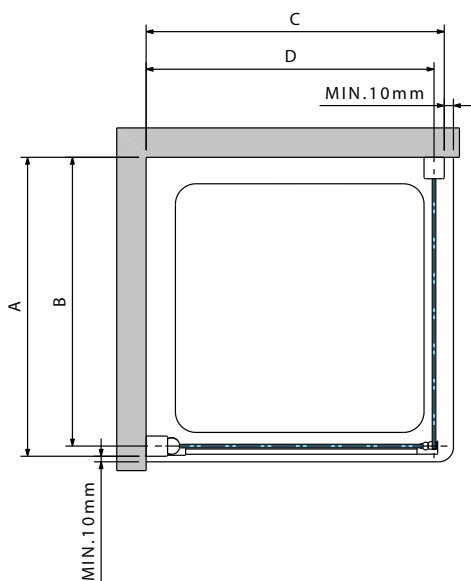

YOUNG 2.0 G+F

Kod	C	D
Y2G57-	57-59	55,4-57,4
Y2G59-	59-61	57,4-59,4
Y2G61-	61-63	59,4-61,4
Y2G65-	65-67	63,4-65,4
Y2G67-	67-69	65,4-67,4
Y2G69-	69-71	67,4-69,4
Y2G72-	72-74	70,4-72,4
Y2G74-	74-76	72,4-74,4
Y2G77-	77-79	75,4-77,4
Y2G79-	79-81	77,4-79,4
Y2G85-	85-87	83,4-85,4
Y2G87-	87-89	85,4-87,4
Y2G89-	89-91	87,4-89,4
Y2G95-	95-97	93,4-95,4
Y2G97-	97-99	95,4-97,4
Y2G99-	99-101	97,4-99,4

YOUNG 2.0 F

Kod	A	B
Y2FG57-	57-59	55,4-57,4
Y2FG59-	59-61	57,4-59,4
Y2FG61-	61-63	59,4-61,4
Y2FG65-	65-67	63,4-65,4
Y2FG67-	67-69	65,4-67,4
Y2FG69-	69-71	67,4-69,4
Y2FG73-	73-75	71,4-73,4
Y2FG75-	75-77	73,4-75,4
Y2FG77-	77-79	75,4-77,4
Y2FG79-	79-81	77,4-79,4
Y2FG85-	85-87	83,4-85,4
Y2FG87-	87-89	85,4-87,4
Y2FG89-	89-91	87,4-89,4
Y2FG95-	95-97	93,4-95,4
Y2FG97-	97-99	95,4-97,4
Y2FG99-	99-101	97,4-99,4
Y2FG117-	117-119	115,4-117,4
Y2FG119-	119-121	117,4-119,4

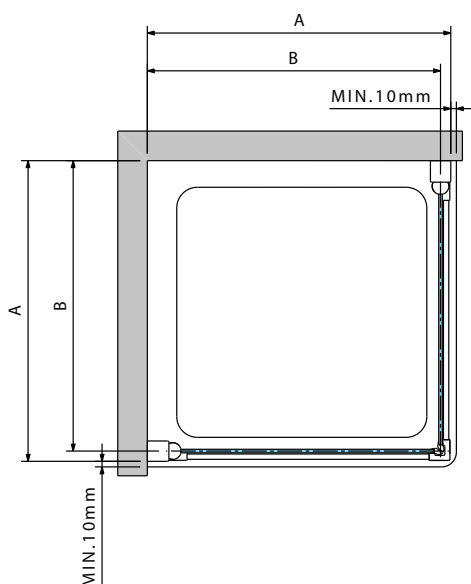

YOUNG 2.0 2G

Kod	C	D
Y22G57	57-59	55,4-57,4
Y22G59	59-61	57,4-59,4
Y22G61	61-63	59,4-61,4
Y22G65	65-67	63,4-65,4
Y22G67	67-69	65,4-67,4
Y22G69	69-71	67,4-69,4
Y22G72	72-74	70,4-72,4
Y22G74	74-76	72,4-74,4
Y22G77	77-79	75,4-77,4
Y22G79	79-81	77,4-79,4
Y22G85	85-87	83,4-85,4
Y22G87	87-89	85,4-87,4
Y22G89	89-91	87,4-89,4
Y22G95	95-97	93,4-95,4
Y22G97	97-99	95,4-97,4
Y22G99	99-101	97,4-99,4

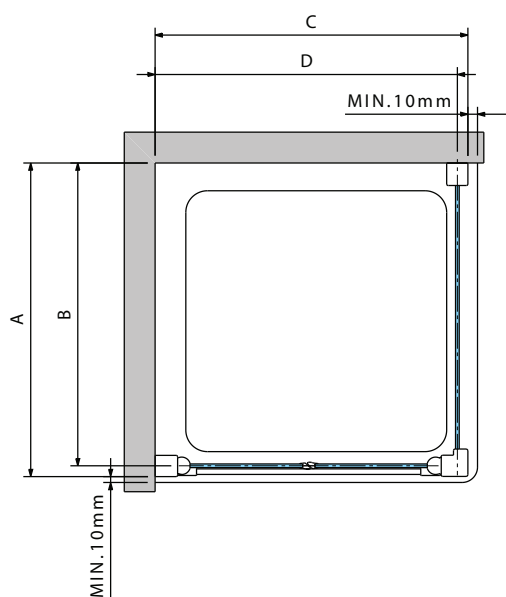

YOUNG 2.0 2B+F2B

Kod	C	D
Y22B57-	58-62	56,6-60,4
Y22B63-	64-68	62,6-66,4
Y22B67-	68-72	66,6-70,4
Y22B71-	72-76	70,6-74,4
Y22B73-	74-78	72,6-76,4
Y22B77-	78-82	76,6-80,4
Y22B83-	84-88	82,6-86,4
Y22B87-	91-95	86,6-90,4
Y22B93-	94-98	92,6-96,4
Y22B97-	98-102	96,6-100,4
Y22B103-	104-108	102,6-106,4
Y22B107-	108-112	106,6-110,4
Y22B113-	114-118	112,6-116,4
Y22B117-	118-122	116,6-120,4
Y22B137-	138-142	136,6-140,4
Y22B147-	148-152	146,6-150,4
Y22B157-	158-162	156,6-160,4
Y22B167-	168-172	166,6-170,4
Y22B177-	178-182	176,6-180,4

YOUNG 2.0 F2B

Kod	C	D
Y2F2B57-	57-59	55,4-57,4
Y2F2B59-	59-61	57,4-59,4
Y2F2B65-	56-58	54,4-56,4
Y2F2B67-	67-69	65,4-67,4
Y2F2B69-	82-86	67,4-69,4
Y2F2B73-	73-75	71,4-73,4
Y2F2B75-	92-96	73,4-75,4
Y2F2B77-	77-79	75,4-77,4
Y2F2B79-	79-81	77,4-79,4
Y2F2B85-	85-87	83,4-85,4
Y2F2B87-	87-89	85,4-87,4
Y2F2B89-	89-91	87,4-89,4
Y2F2B95-	95-97	93,4-95,4
Y2F2B97-	97-99	95,4-97,4
Y2F2B99-	99-101	97,4-99,4
Y2F2B117-	117-119	115,4-117,4
Y2F2B119-	119-121	117,4-119,4

RYSUNKI TECHNICZNE

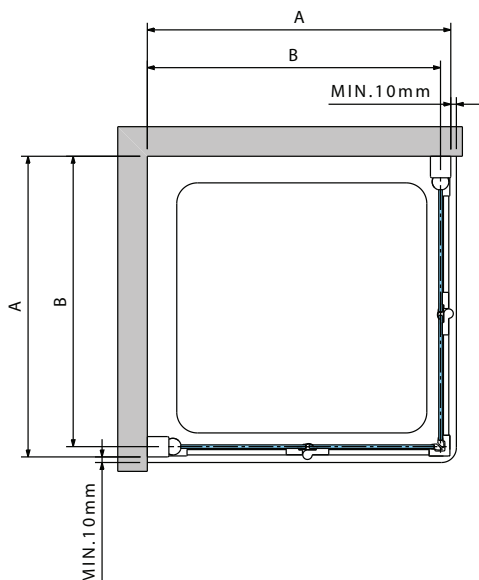
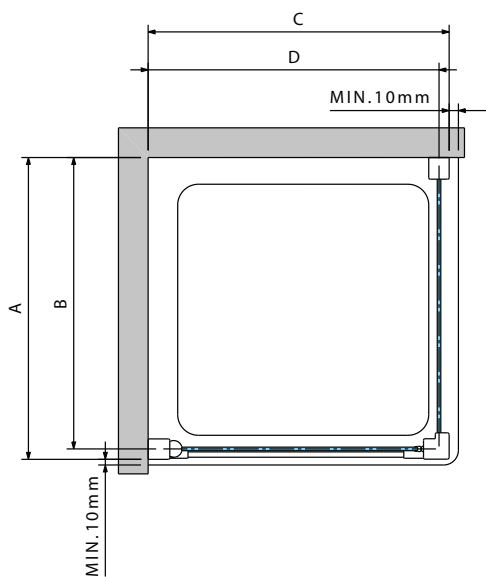

YOUNG 2.0 1B+F1B

Kod	C	D
Y21B57-	58-62	56,4-60,4
Y21B67-	68-72	66,4-70,4
Y21B72-	73-77	71,4-75,4
Y21B77-	78-82	76,4-80,4
Y21B82-	83-87	81,4-85,4
Y21B87-	88-92	86,4-90,4
Y21B92-	93-97	91,4-95,4
Y21B97-	98-102	96,4-100,4

YOUNG 2.0 F1B

Kod	A	B
Y2F1B57-	57-59	55,4-57,4
Y2F1B59-	59-61	57,4-59,4
Y2F1B65-	65-67	63,4-65,4
Y2F1B67-	67-69	65,4-67,4
Y2F1B69-	69-71	67,4-69,4
Y2F1B73-	73-75	71,4-73,4
Y2F1B75-	75-77	73,4-75,4
Y2F1B77-	77-79	75,4-77,4
Y2F1B79-	79-81	77,4-79,4
Y2F1B85-	85-87	83,4-85,4
Y2F1B87-	87-89	85,4-87,4
Y2F1B89-	89-91	87,4-89,4
Y2F1B95-	95-97	93,4-95,4
Y2F1B97-	97-99	95,4-97,4
Y2F1B99-	99-101	97,4-99,4
Y2F1B117-	117-119	115,4-117,4
Y2F1B119-	119-121	117,4-119,4

YOUNG 2.0 2GS

Kod	A	B
Y22GS57L	57-59	55,4-57,4
Y22GS59L	59-61	57,4-59,4
Y22GS65L	65-67	63,4-65,4
Y22GS67L	67-69	65,4-67,4
Y22GS69L	69-71	67,4-69,4
Y22GS73L	73-75	71,4-73,4
Y22GS75L	75-77	73,4-75,4
Y22GS77L	77-79	75,4-77,4
Y22GS79L	79-81	77,4-79,4
Y22GS85L	85-87	83,4-85,4
Y22GS87L	87-89	85,4-87,4
Y22GS89L	89-91	87,4-89,4
Y22GS95L	95-97	93,4-95,4
Y22GS97L	97-99	95,4-97,4
Y22GS99L	99-101	97,4-99,4
Y22GS105L	105-107	103,4-105,4
Y22GS115L	115-117	113,4-115,4
Y22GS117L	117-119	115,4-117,4
Y22GS119L	119-121	117,4-119,4

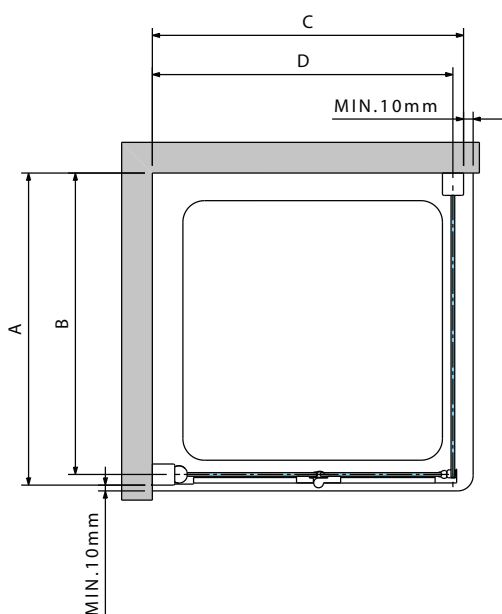

YOUNG 2.0 2GS+F

Kod	C	D
Y22GS57L	58-60	56,4-58,4
Y22GS59L	60-62	58,4-60,4
Y22GS65L	66-68	64,4-66,4
Y22GS67L	68-70	66,4-68,4
Y22GS69L	70-72	68,4-70,4
Y22GS73L	74-76	72,4-74,4
Y22GS75L	76-78	74,4-76,4
Y22GS77L	78-80	76,4-78,4
Y22GS79L	80-82	78,4-80,4
Y22GS85L	86-88	84,4-86,4
Y22GS87L	88-90	86,4-88,4
Y22GS89L	90-92	88,4-90,4
Y22GS95L	96-98	94,4-96,4
Y22GS97L	98-100	96,4-98,4
Y22GS99L	100-102	98,4-100,4
Y22GS105L	106-108	104,4-106,4
Y22GS115L	116-118	114,4-116,4
Y22GS117L	118-120	116,4-118,4
Y22GS119L	120-122	118,4-120,4

YOUNG 2.0 F

Kod	A	B
Y2FG57-	57-59	55,4-57,4
Y2FG59-	59-61	57,4-59,4
Y2FG61-	61-63	59,4-61,4
Y2FG65-	65-67	63,4-65,4
Y2FG67-	67-69	65,4-67,4
Y2FG69-	69-71	67,4-69,4
Y2FG73-	73-75	71,4-73,4
Y2FG75-	75-77	73,4-75,4
Y2FG77-	77-79	75,4-77,4
Y2FG79-	79-81	77,4-79,4
Y2FG85-	85-87	83,4-85,4
Y2FG87-	87-89	85,4-87,4
Y2FG89-	89-91	87,4-89,4
Y2FG95-	95-97	93,4-95,4
Y2FG97-	97-99	95,4-97,4
Y2FG99-	99-101	97,4-99,4
Y2FG117-	117-119	115,4-117,4
Y2FG119-	119-121	117,4-119,4

RYSUNKI TECHNICZNE

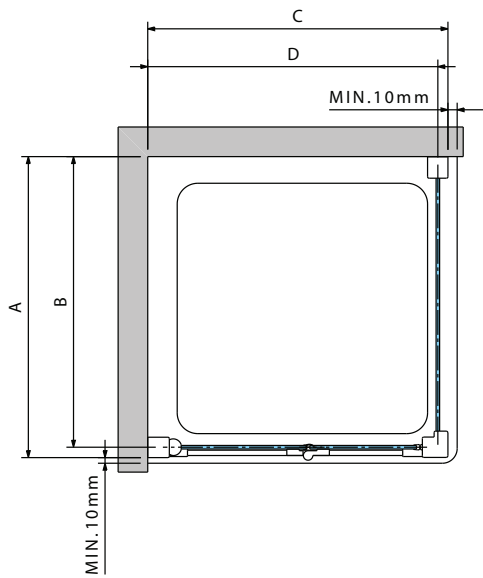

YOUNG 2.0 1BS+F1B

Kod	C	D
Y21BS57	58-62	56,4-60,4
Y21BS67	68-72	66,4-70,4
Y21BS72	73-77	71,4-75,4
Y21BS77	78-82	76,4-80,4
Y21BS82	83-87	81,4-85,4
Y21BS87	88-92	86,4-90,4
Y21BS94	95-99	93,4-97,4
Y21BS97	98-102	96,4-100,4
Y21BS107	107-112	106,4-110,4
Y21BS117	118-122	116,4-120,4

YOUNG 2.0 F1B

Kod	A	B
Y2F1B57-	57-59	55,4-57,4
Y2F1B59-	59-61	57,4-59,4
Y2F1B65-	65-67	63,4-65,4
Y2F1B67-	67-69	65,4-67,4
Y2F1B69-	69-71	67,4-69,4
Y2F1B73-	73-75	71,4-73,4
Y2F1B75-	75-77	73,4-75,4
Y2F1B77-	77-79	75,4-77,4
Y2F1B79-	79-81	77,4-79,4
Y2F1B85-	85-87	83,4-85,4
Y2F1B87-	87-89	85,4-87,4
Y2F1B89-	89-91	87,4-89,4
Y2F1B95-	95-97	93,4-95,4
Y2F1B97-	97-99	95,4-97,4
Y2F1B99-	99-101	97,4-99,4
Y2F1B117-	117-119	115,4-117,4
Y2F1B119-	119-121	117,4-119,4

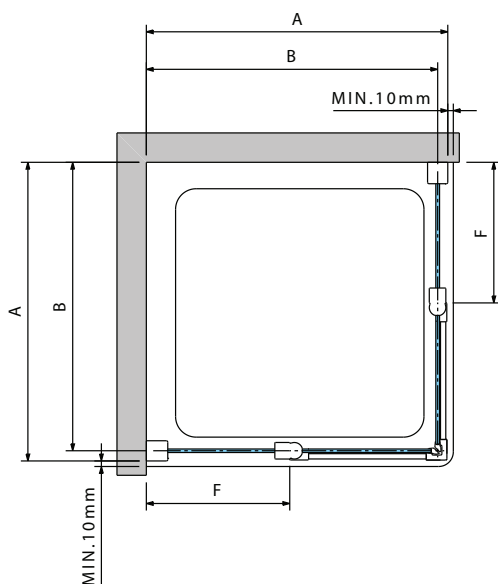

YOUNG 2.0 A

Kod	F	A	B
Y2A57L-	27	57-59	55,4-57,4
Y2A59L-	27	59-61	57,4-59,4
Y2A61L-	27	61-63	59,4-61,4
Y2A65L-	27	65-67	63,4-65,4
Y2A67L-	27	67-69	65,4-67,4
Y2A69L-	27	69-71	67,4-69,4
Y2A73L-	35	73-75	71,4-73,4
Y2A75L-	35	75-77	73,4-75,4
Y2A77L-	35	77-79	75,4-77,4
Y2A79L-	35	79-81	77,4-79,4
Y2A85L-	43	85-87	83,4-85,4
Y2A87L-	43	87-89	85,4-87,4
Y2A89L-	43	89-91	87,4-89,4
Y2A95L-	43	95-97	93,4-95,4
Y2A97L-	43	97-99	95,4-97,4
Y2A99L-	43	99-101	97,4-99,4

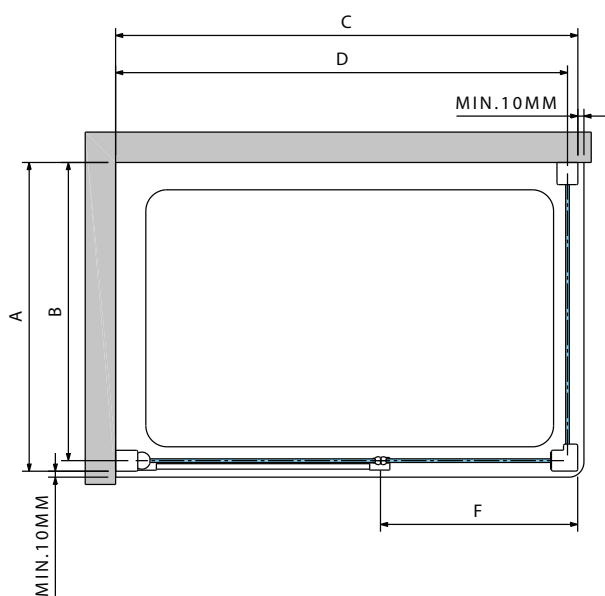

YOUNG 2.0 GFL+F1B

Kod	F	C	D
Y2GFL97	32,5	98-102	96,4-100,4
Y2GFL107	42,5	108-112	106,4-110,4
Y2GFL114	39,5	115-119	113,4-117,4
Y2GFL117	42,5	118-122	116,4-120,4
Y2GFL134	49,5	135-139	133,4-137,4
Y2GFL137	52,5	138-142	136,4-140,4
Y2GFL147	52,5	148-153	146,4-150,4
Y2GFL154	59,5	155-159	153,4-157,4
Y2GFL157	62,5	158-162	156,4-160,4
Y2GFL164	69,5	165-169	163,4-167,4
Y2GFL167	72,5	168-172	166,4-170,4
Y2GFL177	82,5	178-182	176,4-180,4

YOUNG 2.0 F1B

Kod	A	B
Y2F1B57-	57-59	55,4-57,4
Y2F1B59-	59-61	57,4-59,4
Y2F1B65-	65-67	63,4-65,4
Y2F1B67-	67-69	65,4-67,4
Y2F1B69-	69-71	67,4-69,4
Y2F1B73-	73-75	71,4-73,4
Y2F1B75-	75-77	73,4-75,4
Y2F1B77-	77-79	75,4-77,4
Y2F1B79-	79-81	77,4-79,4
Y2F1B85-	85-87	83,4-85,4
Y2F1B87-	87-89	85,4-87,4
Y2F1B89-	89-91	87,4-89,4
Y2F1B95-	95-97	93,4-95,4
Y2F1B97-	97-99	95,4-97,4
Y2F1B99-	99-101	97,4-99,4
Y2F1B117-	117-119	115,4-117,4
Y2F1B119-	119-121	117,4-119,4