

SPECIFICATION SHEET

COLLECTION: DX NOTION
PRODUCT CODE: NOT-148D/2-C/P

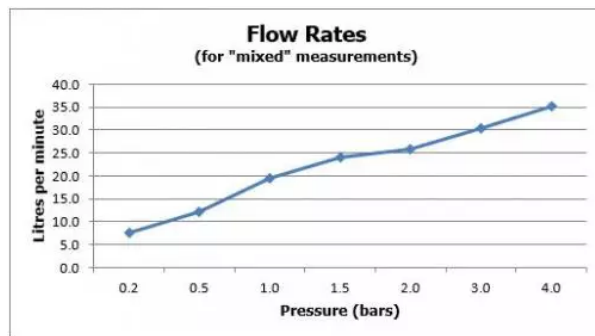
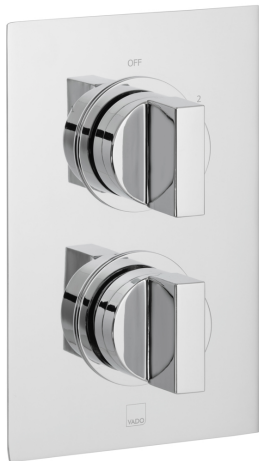

The flow rate displayed is calculated using ideal system conditions. This result should only be taken as an indication as the flow rate may vary depending on the specific in-situ configuration.

SHOWER TYPE

Shower Valve

VALVE TYPE

Concealed

ORIENTATION

Vertical

NUMBER OF OUTLETS

1 Outlet

WITH ALL-FLOW FUNCTION

No

WITH INTEGRATED DIVERTER

No

COMPATIBLE WITH STUDFAST

Yes

WITH BLEED VALVE FOR SYSTEM FLUSH ON INSTALLATION

Yes

WITH SHOWER KIT

No

tel: 01934 744466
email: sales@vado.com
www.vado.com

WHERE INSPIRATION FLOWS
TAPS | SHOWERS | ACCESSORIES



SPECIFICATION SHEET

COLLECTION: DX NOTION
PRODUCT CODE: NOT-148D/2-C/P

INCLUDES MORTAR / TILE GUARD

Yes

COMPATIBLE WITH EASY-FIX BRACKETS

No

WITH THERMOSTATIC TECHNOLOGY

Yes

INSTALLATION TOLERANCES

min-max wall mount 70-95mm optimum installation depth 82mm

CONNECTIONS / FITTINGS

2 x 3/4" female inlets 2 x 3/4" female outlets

SPARE PARTS

thermostatic cartridge V-704-34S diverter cartridge C-803-33X/3X.

MOUNTING

Wall Mounted

PLUMBING SYSTEM SUITABILITY

Gravity System, Pumped System, Combination Boiler, Pressurised System

COLLECTION NAME

DX Notion

FINISH

Chrome

MINIMUM OPERATING PRESSURE

0.2 Bar LP (Shower) / 1.0 Bar MP (Bath)

MAXIMUM OPERATING PRESSURE

5.0 Bar HP

SPECIFICATION SHEET

COLLECTION: DX NOTION
PRODUCT CODE: NOT-148D/2-C/P

GUARANTEE
15 Year Guarantee

tel: 01934 744466
email: sales@vado.com
www.vado.com

WHERE INSPIRATION FLOWS
TAPS | SHOWERS | ACCESSORIES



TECHNICAL DRAWING

COLLECTION: DX NOTION
PRODUCT CODE: NOT-148D/2-C/P

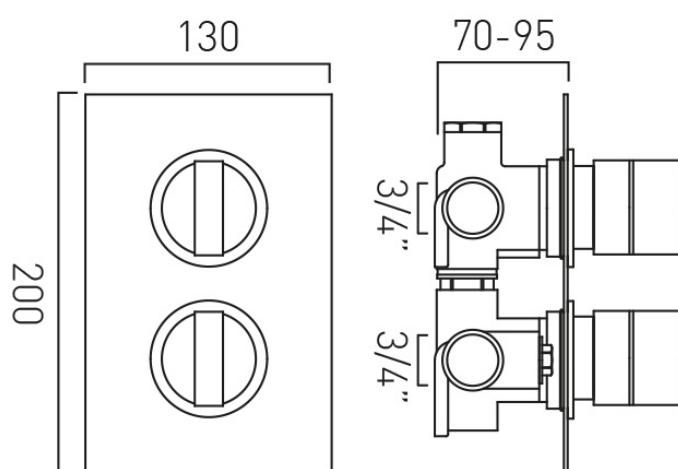

tel: 01934 744466
email: sales@vado.com
www.vado.com

WHERE INSPIRATION FLOWS
TAPS | SHOWERS | ACCESSORIES

